

FIG. 1

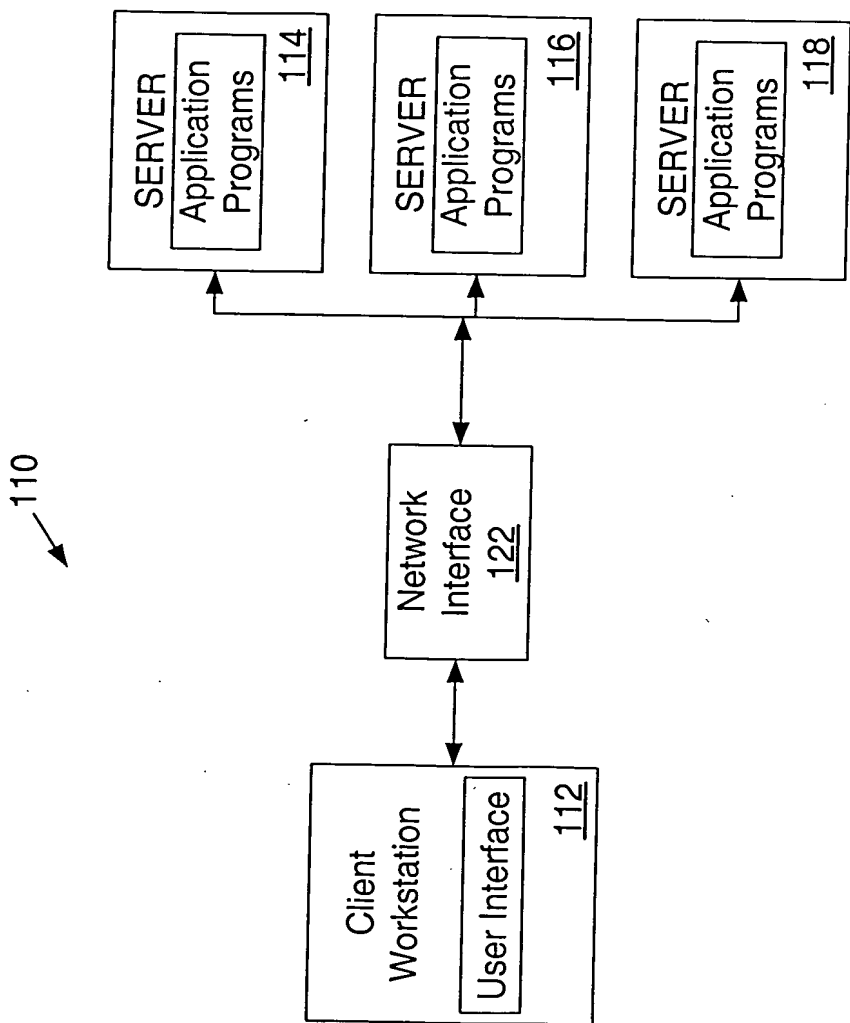

Fig. 1

FIG. 2

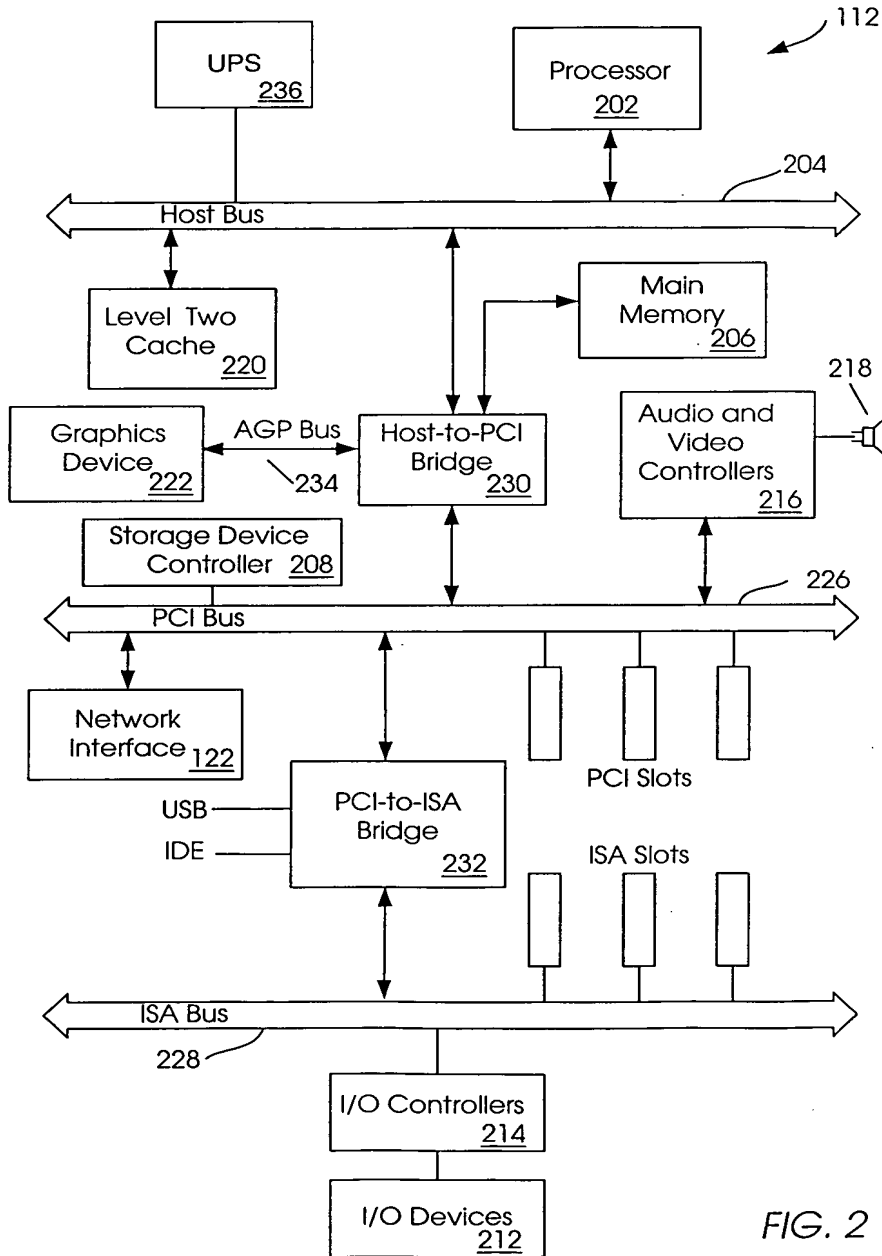

FIG. 2

FOOTCO 82120550

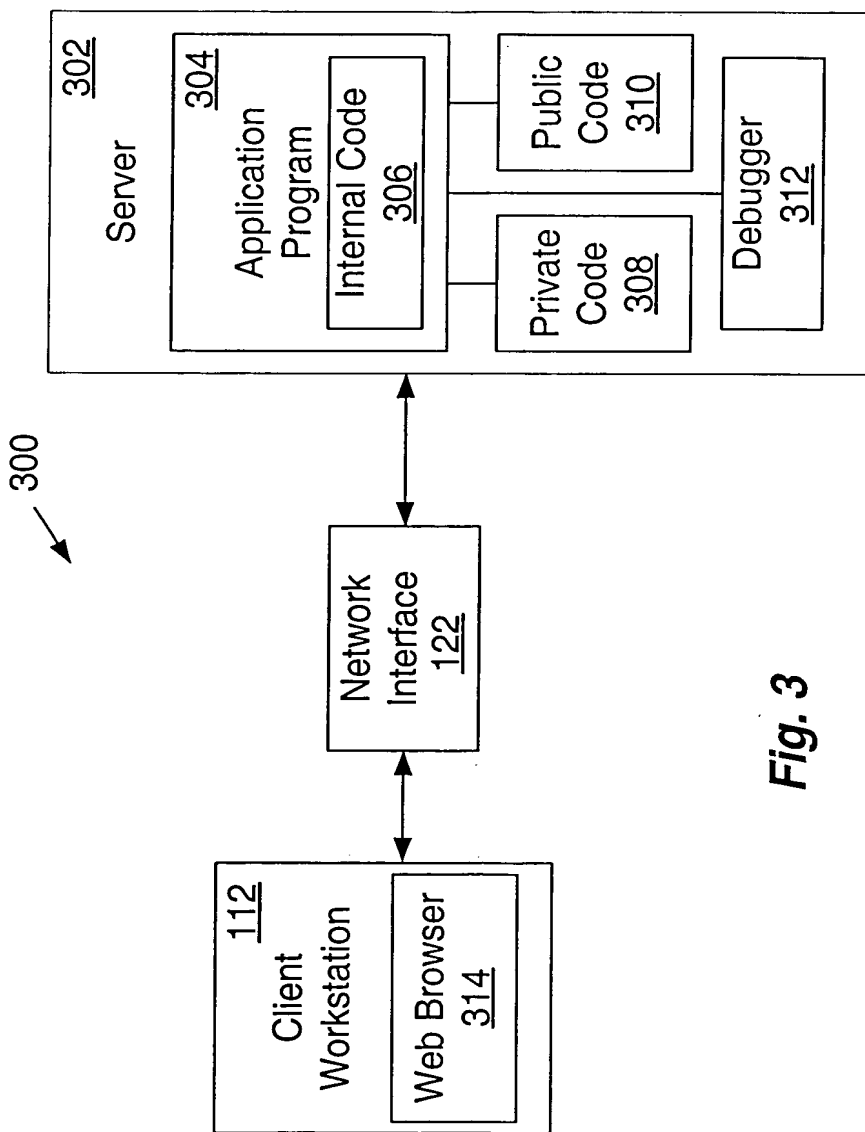

Fig. 3

FOR 20" BATT 20550

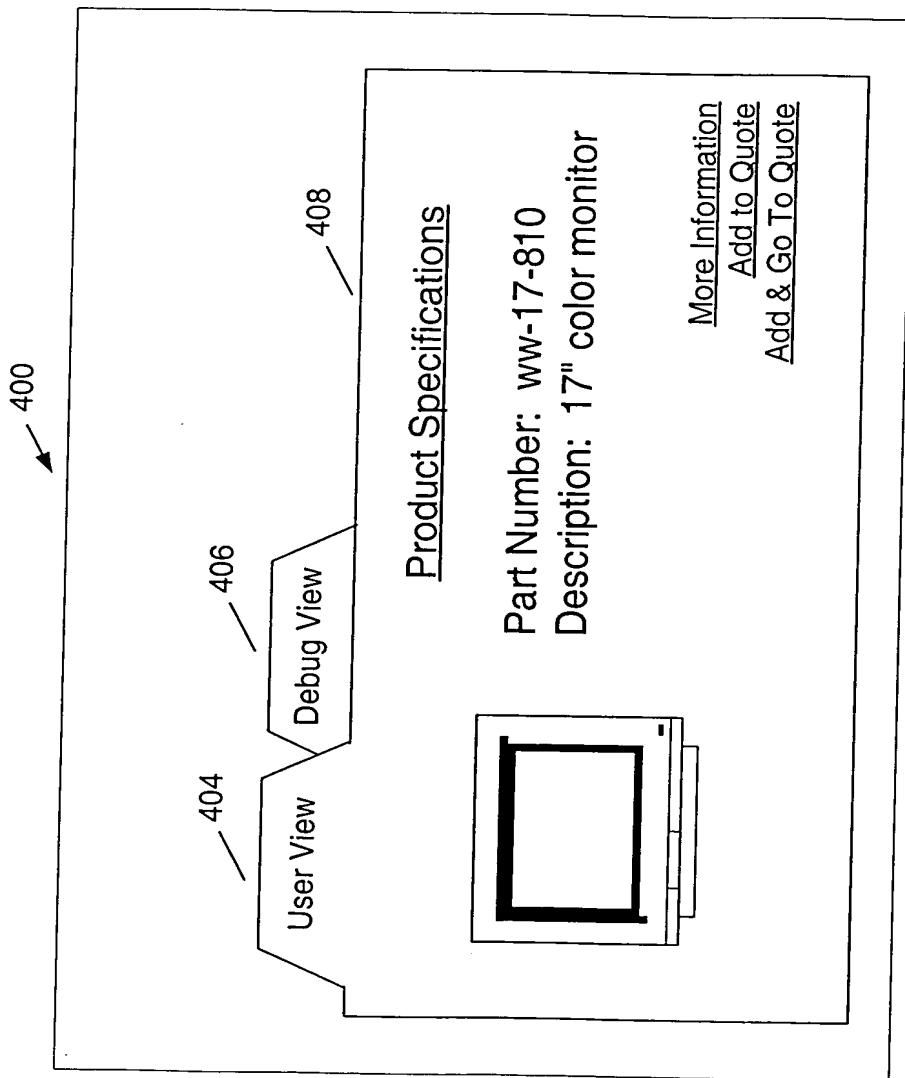

Fig. 4a

FIG. 4b

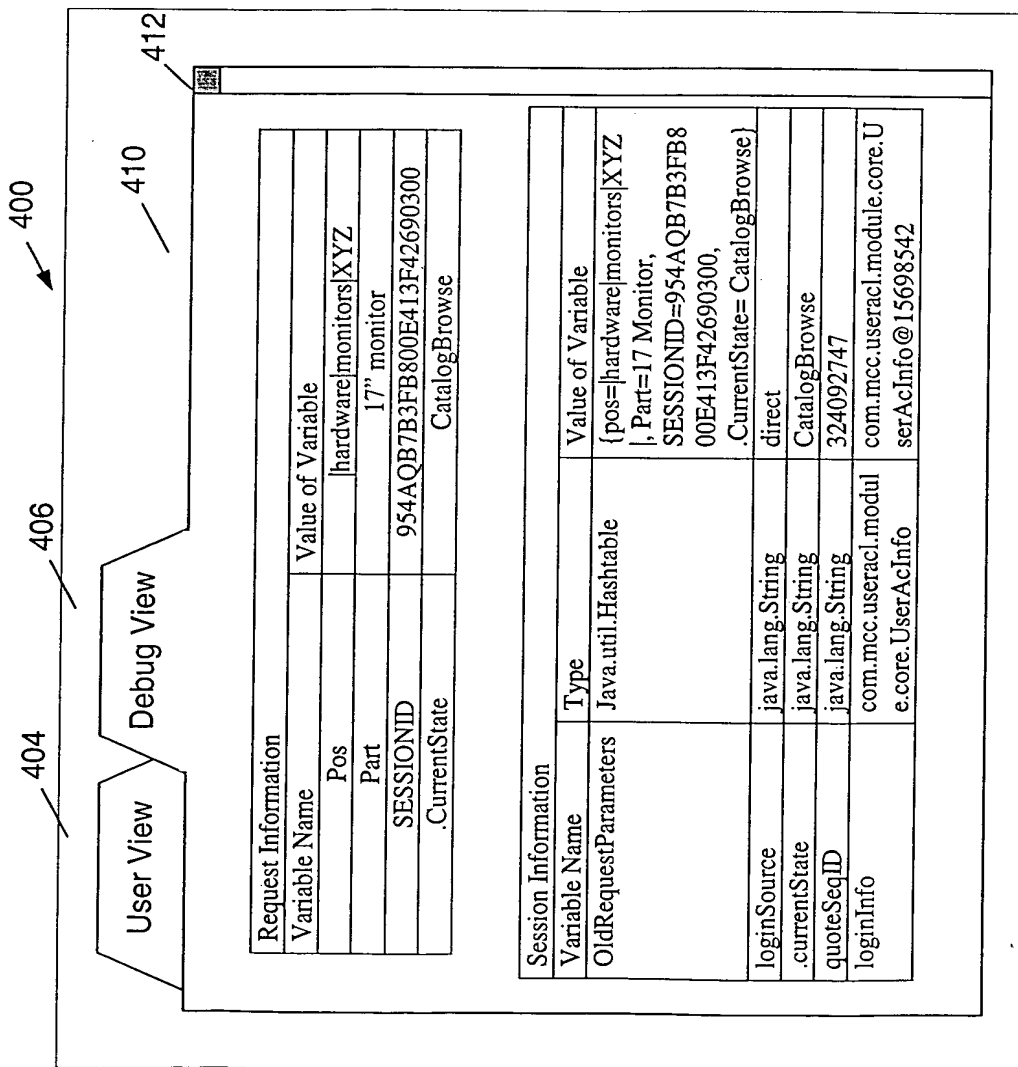

Fig. 4b

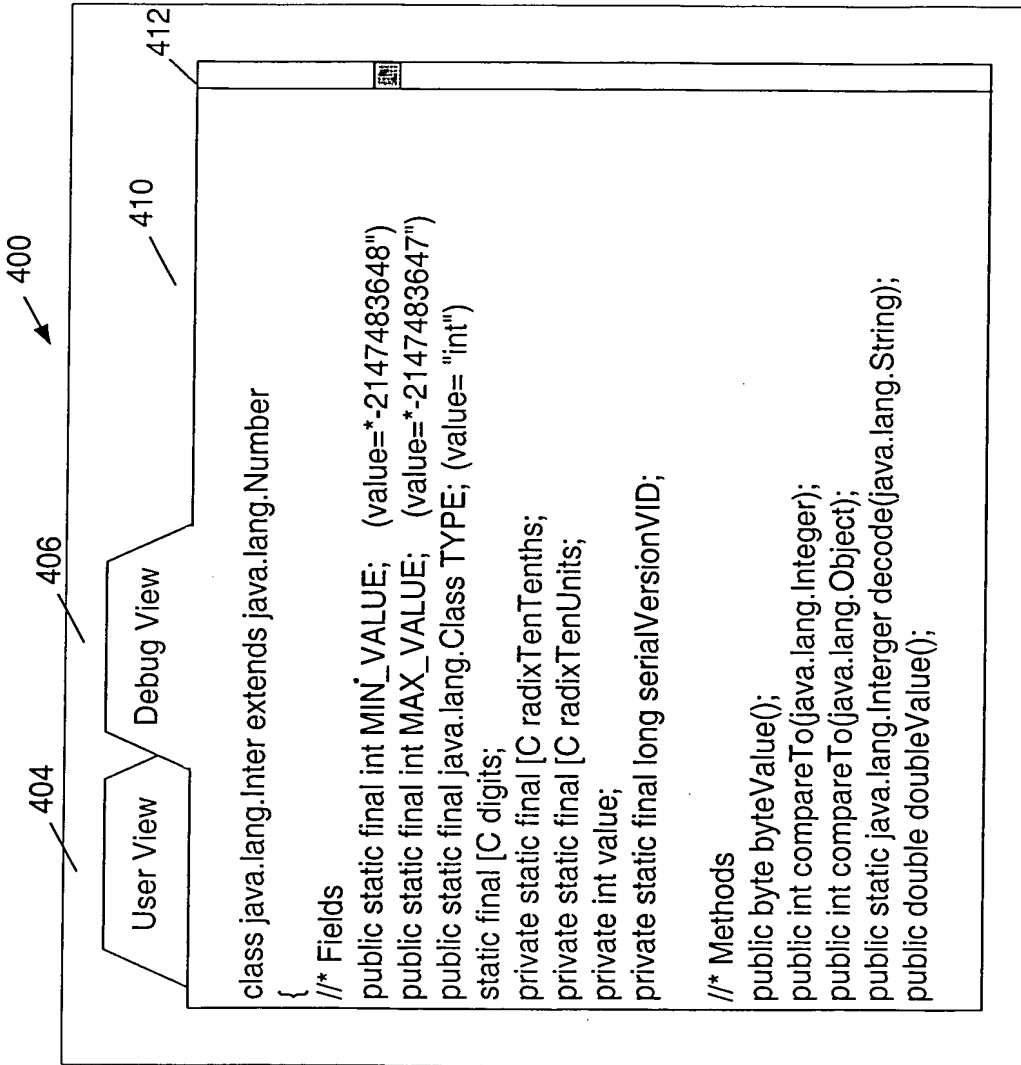

Fig. 4c

FIG. 4d

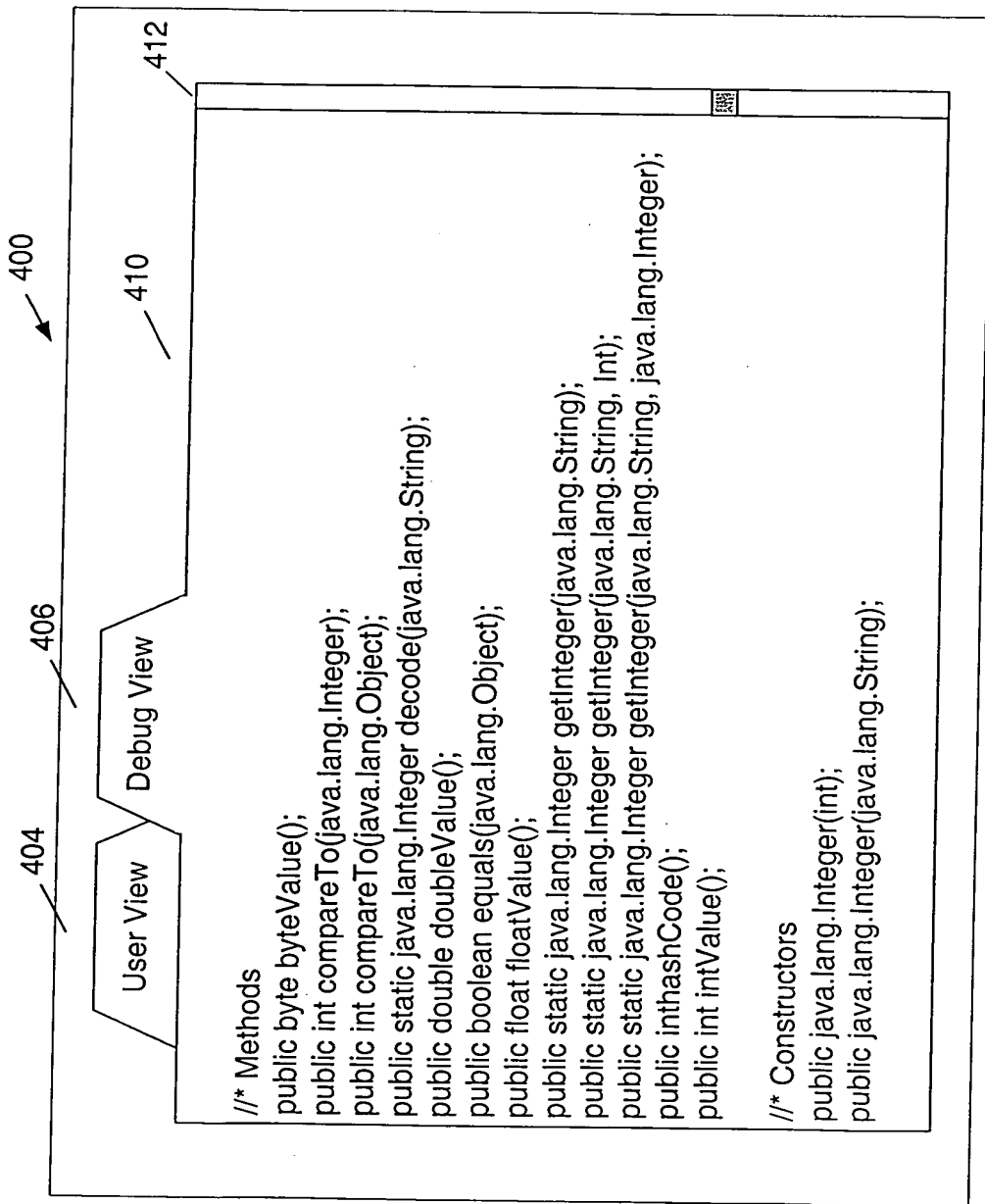

Fig. 4d

T00053-2002-02-20-050

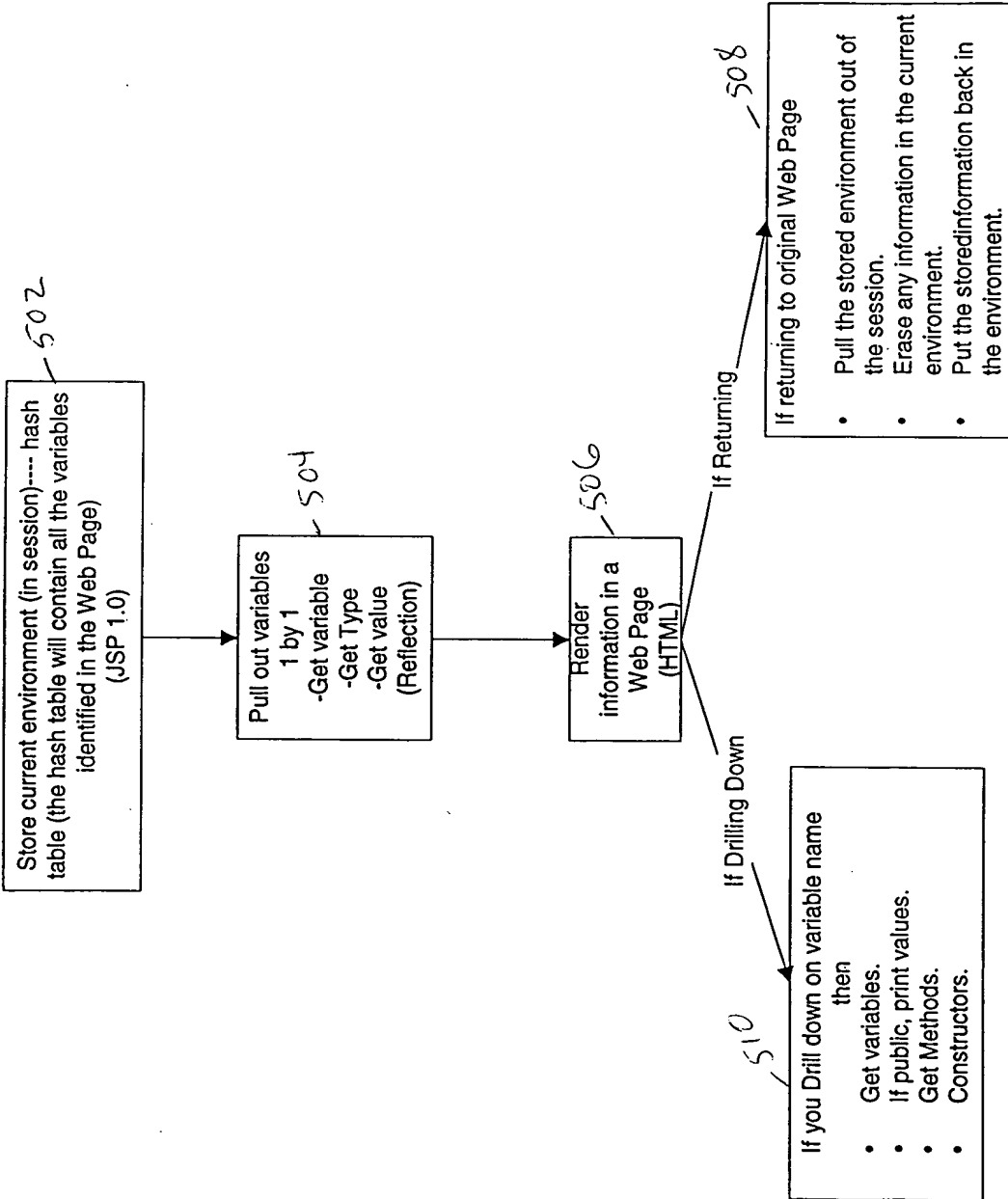

Figure 5